

240x180mm

PHILIPS

Water Solution

ASH3510
ASH3511



How to use

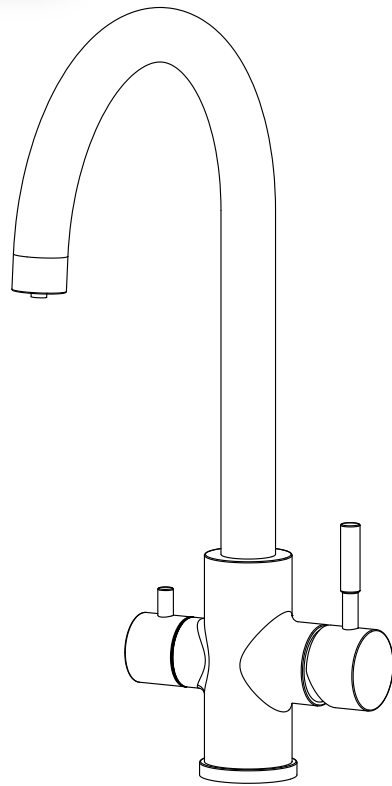

Accessories

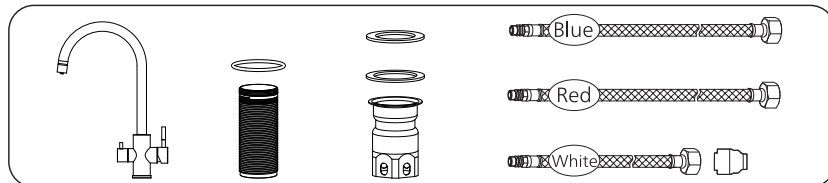

© 2024 AquaShield
All rights reserved.
Philips and the Philips Shield Emblem are registered trademarks of Koninklijke Philips N.V. and are used under license.
This product has been manufactured by and is sold under the responsibility of Hong Kong AquaShield Health Technology Company Limited and Hong Kong AquaShield Health Technology Company Limited is the warrantor in relation to this product.
Rev A JAN 24

Installing the system

1

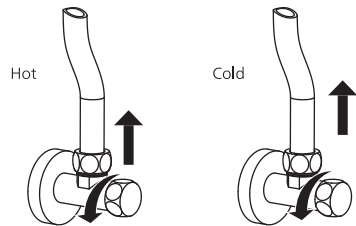

2

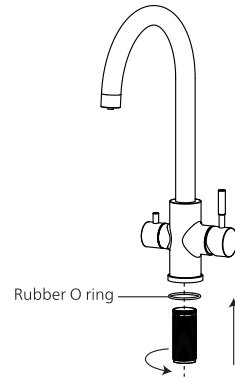

3

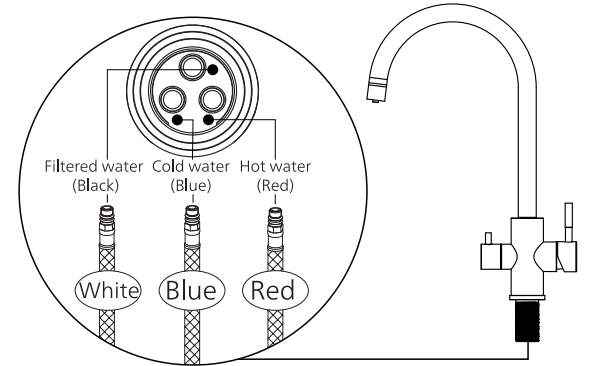

4

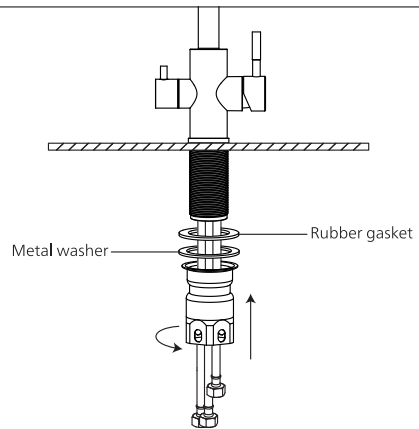

5

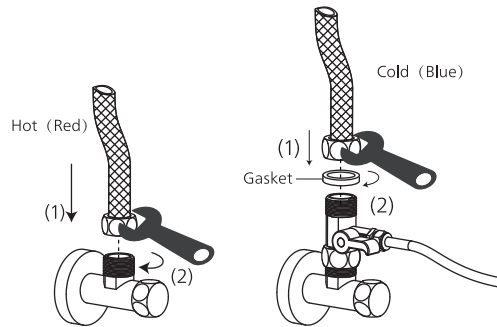

6

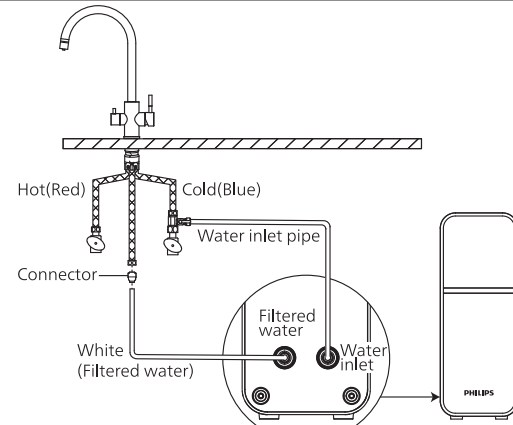

7

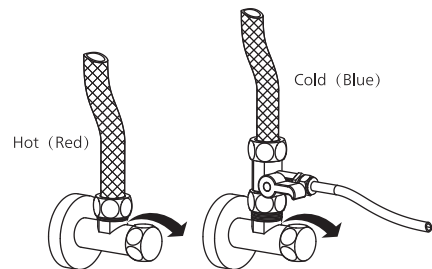

8

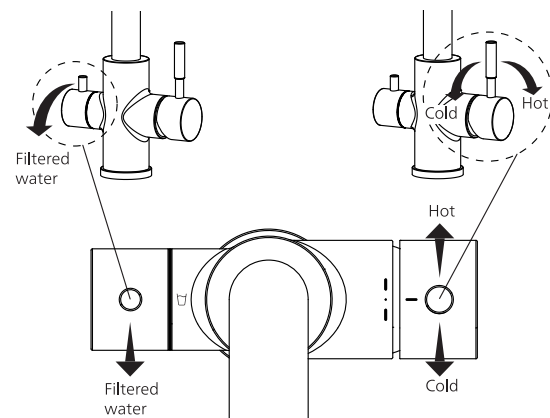

Maintenance

